

TARADOUCHE SHOWER SYSTEM

gerflor.com



Gerflor[®]
theflooringgroup

TARADOUCHE SHOWER SYSTEM 2016





PRESENTATION OF THE RANGE _____ P. 4

- ▶ A COMPLETE SOLUTION _____ p. 4
- ▶ BENEFITS OF THE SYSTEM _____ p. 8
- ▶ COLOR RANGE _____ p. 10
- ▶ TECHNICAL INFORMATION ON COLORS _____ p. 20

TECHNICAL SOLUTION & ACCESSORIES _____ P. 21

- ▶ ACCESSORIES _____ p. 22
- ▶ SPECIFIC TOOLS _____ p. 26
- ▶ MAINTENANCE _____ p. 27
- ▶ PRODUCT DESCRIPTION _____ p. 28
- ▶ TECHNICAL DATASHEET _____ p. 31

SERVICES - ENVIRONMENT _____ P. 32

- ▶ AN ECO-FRIENDLY SOLUTION _____ p. 34

COVERINGS

A COMPLETE SOLUTION

MURAL CALYPSO NORDIC

NEW



FLOORINGS



ELEGANCE SD



TARASAFE STANDARD

NEW

FOR WET AREAS

MURAL CALYPSO

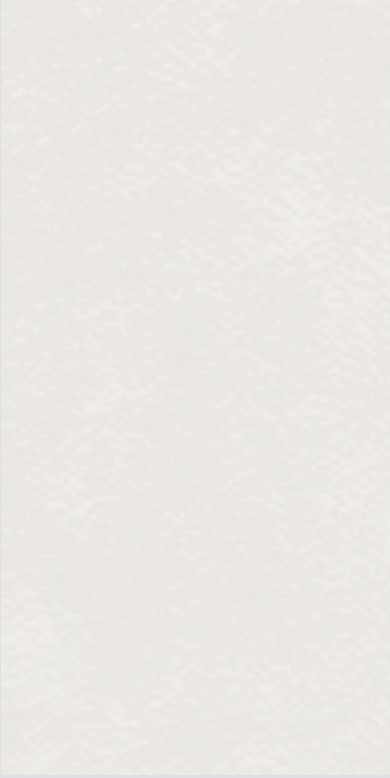

MURAL CALYPSO FABRIC



NEW

MURAL CALYPSO MANHATTAN



NEW



TARASAFE GEO

NEW

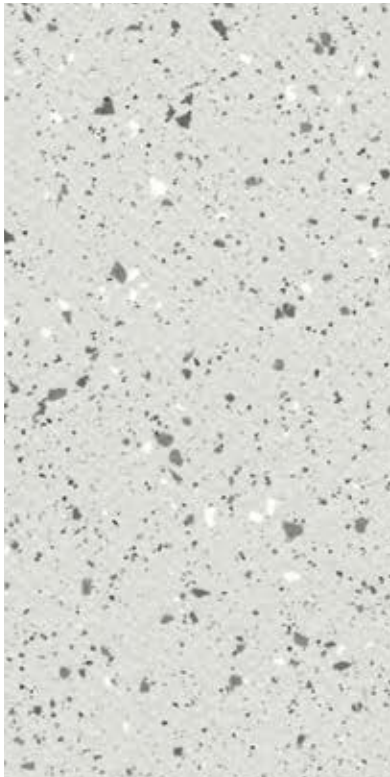

TARASAFE ULTRA

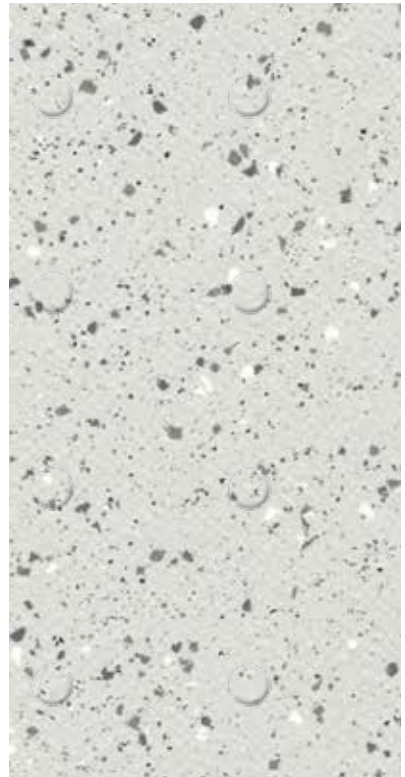

TARASAFE ULTRA H2O

NEW

TARADOUCHE RANGE

STUDENT
RESIDENCE



HOSPITAL /
CLINIC

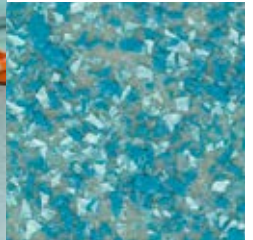

ELDERLY
PEOPLE
HOME



ADAPTED FOR ALL APPLICATIONS

HOTELS

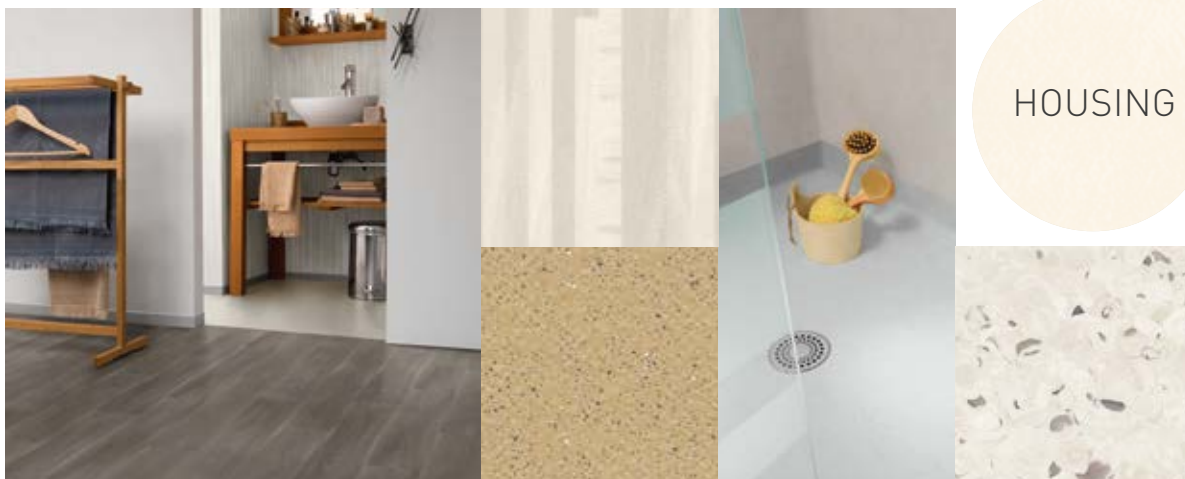

HOUSING

LOCKERS

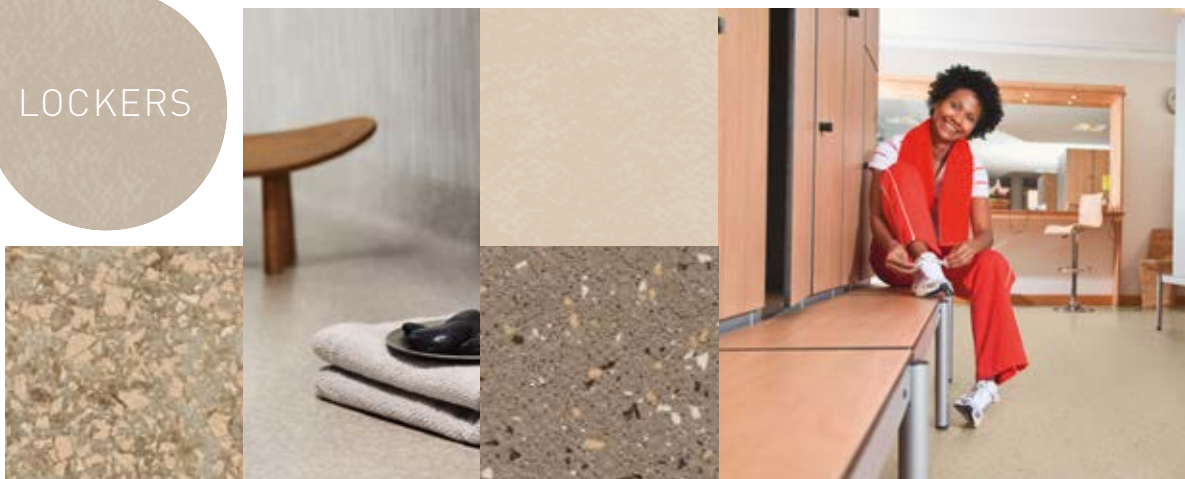

BENEFITS OF THE SYSTEM



SAFETY FOR PATIENTS, RESIDENTS AND EMPLOYEES

- **Compliance with barefoot and shod slip resistance norms** (DIN 51 097, DIN 51 130 and EN 13845)
- **Compliance with most “access to all” laws** (shower without tray)
- **Compliance with fire norm** EN 13501 and regulations for floorings and wall covering (B-s2,d0)

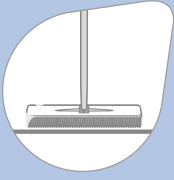

HYGIENE AND EASIER MAINTENANCE

- Smooth and washable products
- Cove former and Gerflor Corner System for easier maintenance in angles
- Easy and economical maintenance
- Surface treatment on Tarasafe Ultra/Standard/Geo



DECORATIVE PRODUCTS

- Attractive range of colors which enables more than **1400 combinations** between floors / wall to create calm, warm, Zen or light ambiances!
- Possibility to compose tone on tone surfaces without strong break between two floors especially for Alzheimer units thanks to the 3 colors of threshold
- Colour throughout the thickness for Mural Calypso to ensure a nice aspect of the welding (no white marks)

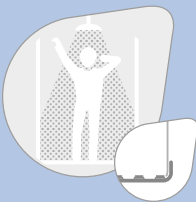

DURABLE AND WATERPROOF INSTALLATION

- Complete solution with flooring-wall covering-accessories for a **100% waterproof** installation
- Hot welding on floor and wall coverings
- Floorings: 2 types of products > heterogeneous or homogeneous
- Vertical or horizontal installation for Mural Calypso
- Gerflor corner system for durability



ECO-FRIENDLY SOLUTION

- 100% recyclable products
- Products manufactured in Europe in ISO 14001 certified factories
- Up to 50% of mineral or renewable material
- Recycled raw material 100% REACH compliant
- Low VOC emissions





7744 Nordic Milk

Mural Calypso



7315 Fabric Jute

Mural Calypso



7302 Sahara

Tarasafe Standard



7618 Edelweiss

Tarasafe Standard



0322 Jicama

Elegance SD



3303 Desert

Tarasafe Geo



7312 Dune

Tarasafe Standard

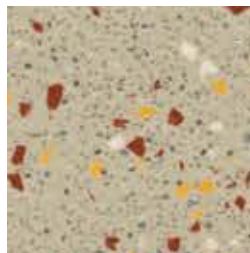

7384 Citrine

Tarasafe Ultra

H₂O



3105 Sunspot

Tarasafe Geo



Presentation of the range



Mural Calypso

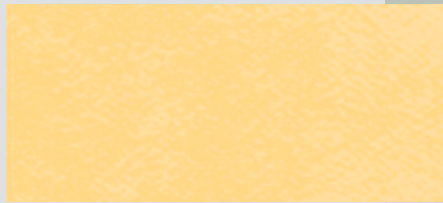

7201 Moonlight

Mural Calypso



7104 Melon

Mural Calypso



7323 Ochre

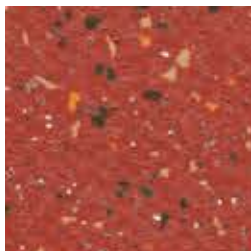

Tarasafe Ultra

4128 Ruby

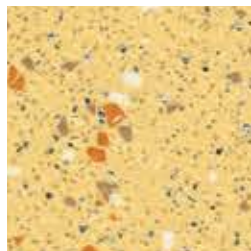

Tarasafe Ultra

4323 Sandstone

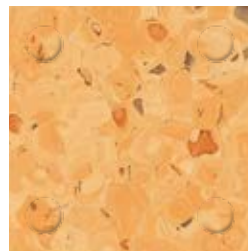

Elegance SD

0700 Melon

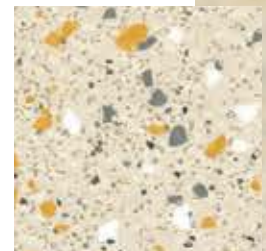

Tarasafe Ultra

7383 Diopside

H₂O



Tarasafe Standard

7115 Flame

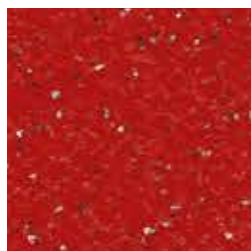

Tarasafe Standard

7107 Poppy



Elegance SD

0333 Ananas



H₂O Tarasafe Ultra H2O - 7325 Seashore

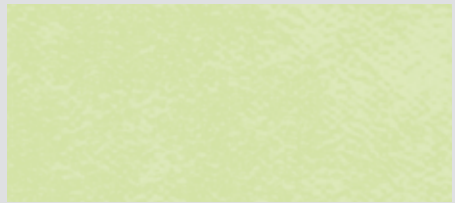

Mural Calypso

7505 Anise

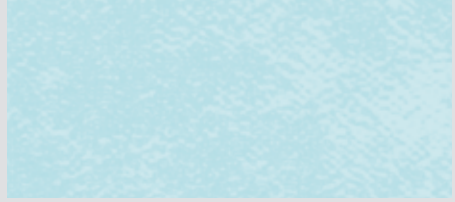

Mural Calypso

7412 Glow



Mural Calypso

7420 Lagoon



Elegance SD

0338 Kiwi

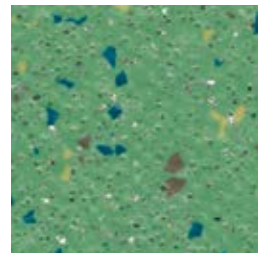

Tarasafe Ultra

4508 Jade

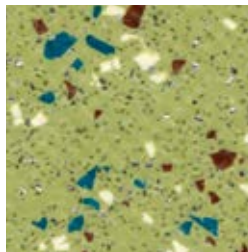

Tarasafe Ultra

4505 Peridot

H₂O



Tarasafe Standard

7508 Avocado

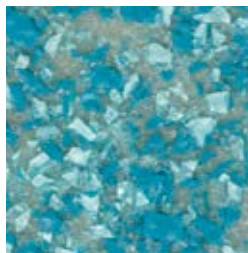

Tarasafe Geo

3405 Turquoise

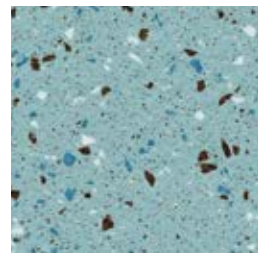

Tarasafe Ultra

4463 Aqua

H₂O Tarasafe Ultra H2O - 7513 Seagrass

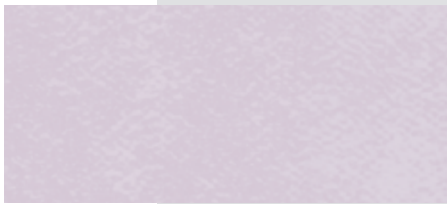

7112 Lilac

Mural Calypso



7110 Fushia

Mural Calypso



7408 Skyline

Mural Calypso

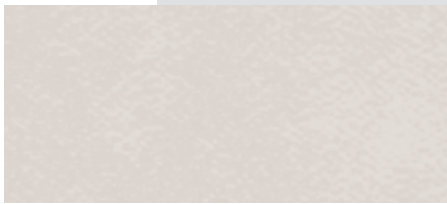

7715 Crystal

Mural Calypso

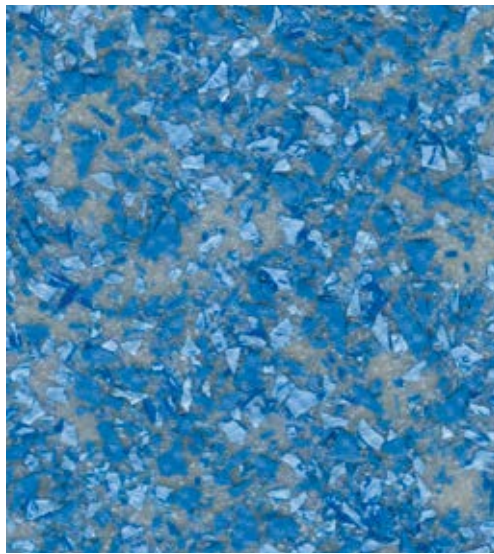

3409 Ocean Wave

Tarasafe Geo

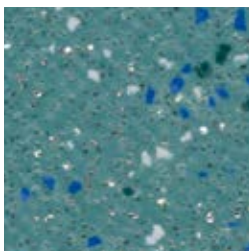

4460 Topaz

Tarasafe Ultra

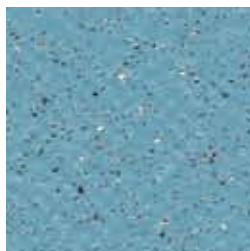

7704 Sky Blue

Tarasafe Standard



0341 Billberry

Elegance SD

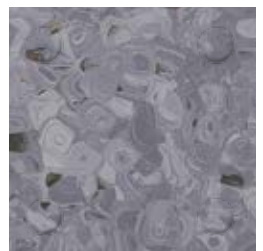

0704 Raspberry Grey

Elegance SD



7414 Fabric Denim

Mural Calypso



7740 Fabric Silk

Mural Calypso

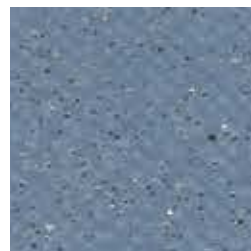

7438 Baleine

Tarasafe Standard

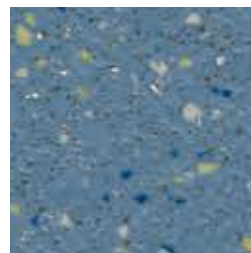

4465 Cobalt

Tarasafe Ultra

H₂O

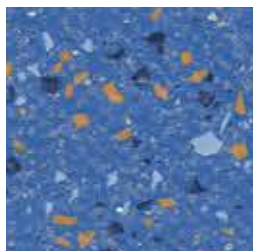

4470 Sapphire

Tarasafe Ultra

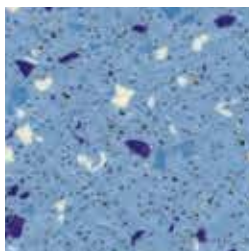

7482 Halite

Tarasafe Ultra

H₂O



7709 Royal Blue

Tarasafe Standard



4472 Moonstone

Tarasafe Ultra

H₂O Tarasafe Ultra H₂O - 7418 Marine / 7413 Ocean Blue

Mural Calypso



7721 Manhattan Mist

Mural Calypso



7728 Manhattan Stone

Mural Calypso



7734 Manhattan Concrete

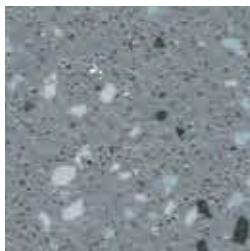

Tarasafe Ultra

8709 Granite

H₂O

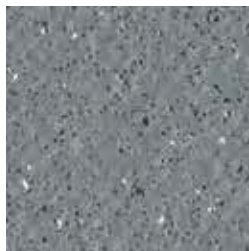

Tarasafe Standard

7773 Storm



Tarasafe Ultra

8710 Basalt



Tarasafe Standard

7801 Noir

H₂O Tarasafe Ultra H2O - 7746 Stone

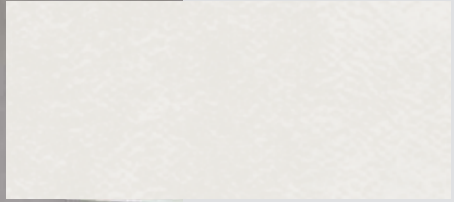

Mural Calypso

7711 Ice

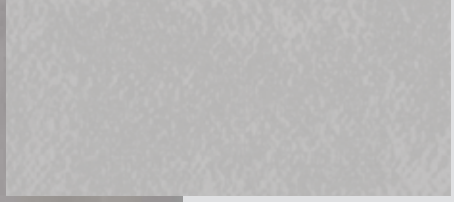

Mural Calypso

7714 Frost

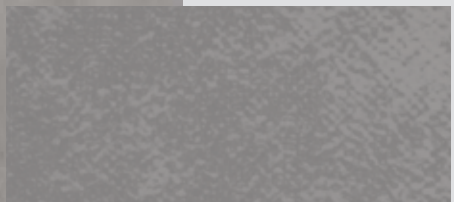

Mural Calypso

7751 Steel



Tarasafe Ultra

8717 Obsidian



Tarasafe Geo

3771 Rock



Elegance SD

0705 Patisson



Tarasafe Standard

7731 Marbre

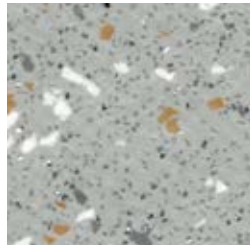

Tarasafe Ultra

8704 Peeble

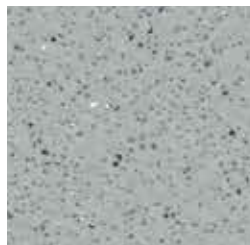

Tarasafe Standard

7767 Dove Grey

H₂O Tarasafe Ultra H2O - 7732 Gravel

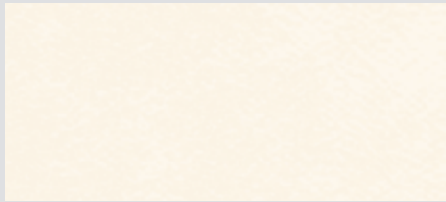

7611 Snow

Mural Calypso



7309 Lotus

Mural Calypso



7311 Linen

Mural Calypso

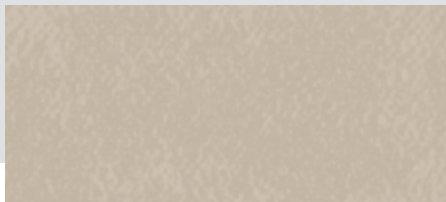

7712 Shadow

Mural Calypso



3775 Crystalline

Tarasafe Geo

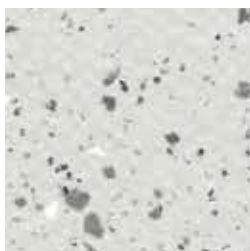

8701 Opal

Tarasafe Ultra



H2O Tarasafe Ultra H2O
7720 Iceberg





Mural Calypso

7753 Nordic Zen

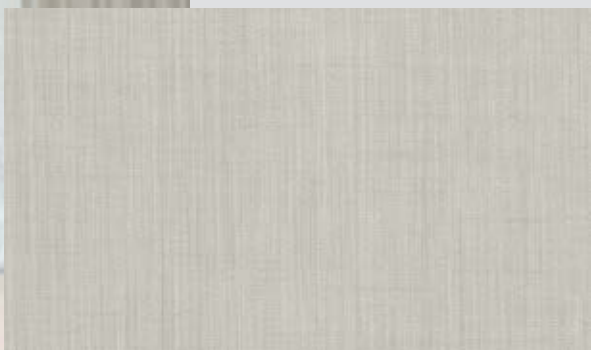

Mural Calypso

7736 Fabric Wool



Tarasafe Standard

7386 Savana



Elegance SD

0329 Hazelnut



Tarasafe Ultra

8013 Jasper



Tarasafe Geo

8081 Trail



Tarasafe Geo

3772 Cliff

TECHNICAL INFORMATION ON COLORS

COLORS	LVR Light Reflectance Value (Luminance)	NCS
--------	---	-----

TARASAFE ULTRA

8701 Opal	64,4	1002-B
8709 Granite	23,1	5502-B
8717 Obsidian	9,2	7502-B
7383 Diopside	60,7	1005-Y20R
7482 Halite	31,2	3030-R90B
8013 Jasper	21,2	6010-Y30R
4128 Ruby	13,4	4045-Y90R
4323 Sandstone	50,7	2030-Y10R
4505 Peridot	36,0	3030-G60Y
4508 Jade	27,7	3040-G20Y
4460 Topaz	21,8	4030-B30G
8704 Pebble	42,7	3000-N
4463 Aqua	36,4	3020-B40G
4465 Cobalt	22,9	4020-R90B
4427 Moonstone	11,2	6020-R90B
7384 Citrine	41,2	3010-Y10R
8710 Basalt	11,2	7502-Y
4470 Sapphire	15,6	3050-R80B

TARASAFE STANDARD

7618 Edelwess	59,8	1505-Y10R
7773 Storm	20,8	5502-B
7801 Noir	4,3	9000-N
7312 Dune	45,5	2010-Y20R
7438 Baleine	21,6	4020-R90B
7508 Avocado	31,3	4010-G20Y
7107 Poppy	10,3	2570-Y90R
7115 Flame	18,2	3050-Y70R
7767 Dove Grey	33,8	3502-G
7386 Savana	41,9	3005-Y20R
7731 Marbre	48,9	2002-B
7302 Sahara	35,8	3020-Y20R
7704 Sky blue	30,5	3030-B10G
7709 Royal blue	15,1	4040-R80B

TARASAFE GEO

3772 Cliff	42,7	3005-Y20R
3775 Crystalline	38,9	3005-R80B
3771 Rock	31,3	3502-B
3405 Turquoise	30,9	3030-B30G
3303 Desert	44,1	3010-Y30R
3409 Ocean Wave	23,5	4030-R90B
3105 Sunspot	25,9	2050-Y70R
8081 Trail	33,0	4010-Y40R

ELEGANCE SD

0704 Rasperry Grey	20,3	5005-R80B
0341 Bilberry	34,8	2040-B10G
0329 Hazelnut	36,4	3010-Y40R
0338 Kiwi	47,9	1040-G50Y
0700 Melon	48,2	1040-Y30R
0333 Ananas	57,9	0550-Y10R
0705 Patisson	64,4	1502-Y
0322 Jicama	67,8	1505-Y20R



COLORS	LVR Light Reflectance Value (Luminance)	NCS
--------	---	-----

TARASAFE ULTRA H20

7720 Iceberg	21,8	1002-B
7746 Stone	23,1	5502-B
7732 Gravel	9,2	7502-B
7325 Seashore	60,7	1005-Y20R
7418 Marine	31,2	3030-R90B
7413 Ocean Blue	22,9	4020-R90B
7513 Seagrass	36,0	3030-G60Y
7314 Sand	41,2	3010-Y10R

MURAL CALYPSO

7734 Manhattan Concrete	21,8	5500-N
7323 Ochre	22,2	2060-Y80R
7751 Steel	24,2	5500-N
7110 Fushia	25	2040-R40B
7315 Fabric Jute	34,5	4010-Y10R
7728 Manhattan Stone	39,5	3502-Y
7712 Shadow	40,7	3005-Y50R
7420 Lagoon	41,1	2020-B40G
7714 Frost	43,8	3000-N
7414 Fabric Denim	46,5	2020-R90B
7753 Nordic Zen	47,8	2502-Y
7736 Fabric Wool	49,4	2502-Y
7112 Lilac	54,5	2010-R50B
7311 Linen	56,5	1505-Y40R
7408 Skyline	56,8	1515-R90B
7740 Fabric Silk	58,8	1502-Y
7715 Crystal	60,6	1502-R
7104 Melon	61	1030-Y20R
7412 Glow	63,7	1020-B10G
7412 Manhattan Mist	64,6	1502-Y
7744 Nordic Milk	67,5	1502-Y
7505 Anise	70,2	0530-G40Y
7201 Moonlight	70,5	0530-Y10R
7711 Ice	70,7	1002-G
7309 Lotus	75,5	0804-Y30R
7611 Snow	82,8	0502-G50Y

TARADOUCHE SHOWER SYSTEM

FLOOR/WALL & ACCESSORIES SYSTEM FOR BATHROOM

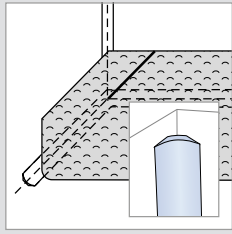

Cove former for internal wall angles CA 12 - H204



Perfect WR 41 wall weld - H231

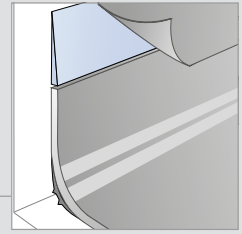

Diminishing profile - 0490

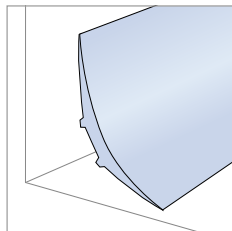

Cove former - 0478

PVC drain with inox grid - H090



Tarafoam: acoustic insulation sub-layer - 997C

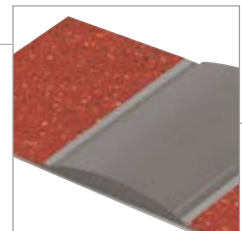

Shower threshold - 0469



Drains - H112 / H113

The threshold has been developed in 3 colours
grey, beige and blue
in order to answer to the specific requirement
of Alzheimer units (no contrast).

- gris ●
- beige clair ○
- bleu ●

PVC DRAINS

Description



PVC DRAIN WITH INOX GRID

H090



SITAR DRAIN

H112

Drains are made from white injected PVC.



SITAR V DRAIN

H113

Colours



001



001



001

Benefits

- ▶ Adjustable height (up to 85 mm with extension)
- ▶ For vertical exit (or horizontal when an elbow - not supplied - is fitted)
- ▶ Flow rate: 0,6 liter per second

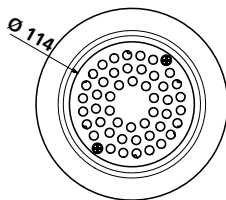
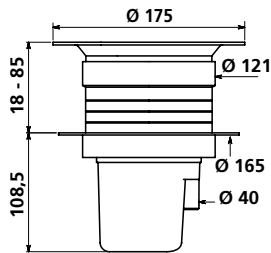

- ▶ An adjustable ring depending on the screeds
- ▶ Height adjustment
- ▶ **2 outlets (horizontal and vertical)** allow for flexibility on site
- ▶ 50 mm trap seal

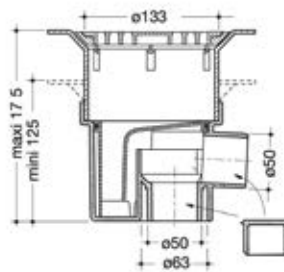

Packaging Unit

- ▶ **Integral drain with vertical drainage**
- ▶ 50 mm trap seal

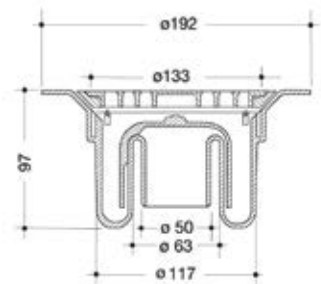

Packaging Unit

Tips

- The floor covering is filled into the gully to a watertight seal.

ACCESSORIES

COVE FORMER FOR INTERNAL ANGLES

TARAFOAM

Description

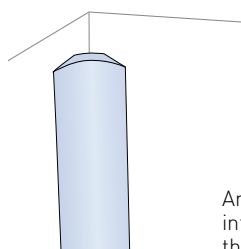

CA12

H204

Angle bead to be placed in the internal angles before installing the wall covering

Colours



0719

Benefits

- ▶ Eliminates potential puncture damage to internal corners
- ▶ Size: 12 mm

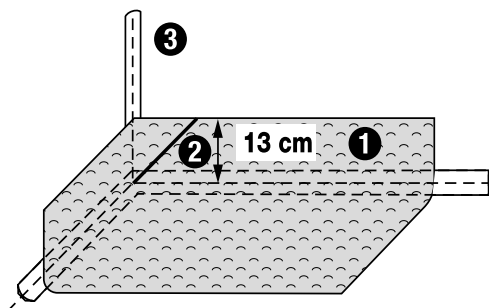

- 1 Cove the floor up to a height of 130 mm.
- 2 Cut the floor covering at 45° and weld the CR 40 rod.
- 3 Wall angle: double bonding of the CA 12 to the entire height.

Packaging
1 x 50 lm coil

Tips



COMFORT VERSION
OF THE SHOWER
SYSTEM

997C 6792

- ▶ Provides **acoustic insulation for the shower system** and comfort under foot.
- ▶ Thickness: 2mm.

Packaging
Roll of 2 m x 20 lm

- Levels out around the edge of the room.
- Acrylic bonding.
- Edge to edge installation.

PVC WALL COVERING/COVING JUNCTION

COVE FORMER

Description

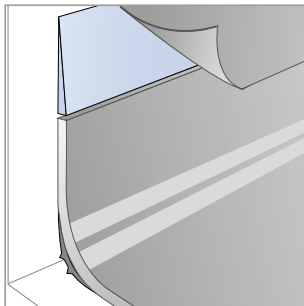

DIMINISHING PROFILE

Coving/wall covering connection

Used in laboratories, hospital shower systems, commercial kitchens

0490

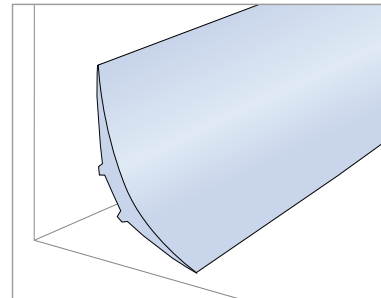

PVC COVE FORMER

0478

Colours



6512



6512

Benefits

- ▶ Makes it easier to link the floor covering and wall
- ▶ **Hygienic.** Avoids bacteria accumulation
- ▶ **Prevents** the floor covering from **tearing**, improves **durability** and ensures **watertightness**.

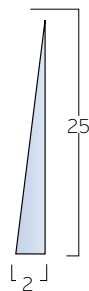

Packaging
2 x 25 lm rolls

- ▶ Enables coving and allows **watertightness**
- ▶ Its rounded shape **makes it easier to clean** the floor/wall junction
- ▶ Offers a better look
- ▶ Limits the risk of piercing the floor covering
- ▶ **Prevents accumulation** of bacteria.

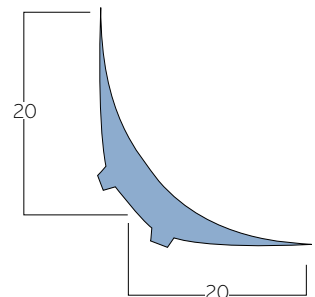

Packaging
20 x 3 lm strips

Tips

- Bond with acrylic adhesive

- Only a single 45° angle is cut
- Double bonding (polychloropene type)
- Use a miter shear for a perfect cut

PVC SHOWER THRESHOLD PROFILE

Description

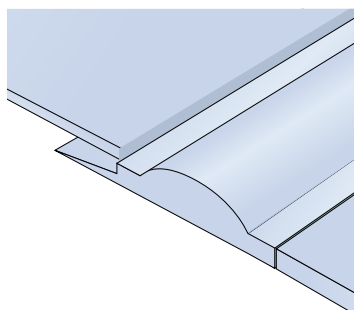

PVC SHOWER THRESHOLD PROFILE

Makes the junction between a floor covering and a shower covering

0469

Colours

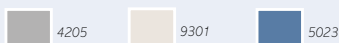

Benefits

- ▶ Allows welding of 2 mm or 3.5 mm floor covering thanks to the tab system
- ▶ Weld system with the covering which ensures perfect watertightness

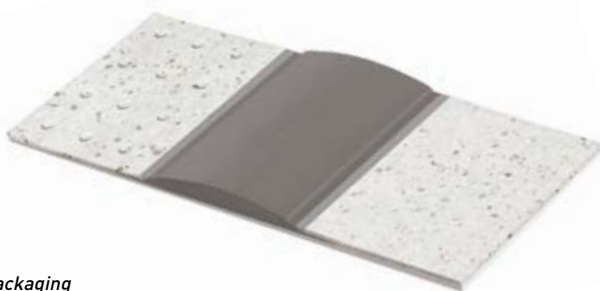
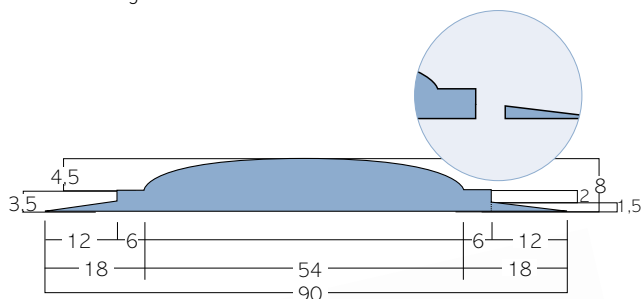

Packaging
10 x 3 lm strips

Tips

- The tab can be cut to suit a thicker floor
- Polychloroprene double bonding
- Application of sealant around the door jamb (PU or MS polymer sealant)



SPECIFIC TOOLS

LIST OF SPECIFIC TOOLS

ROMUS

e-mail : commercial@romus.fr

JANSER S.A.

LIST OF SPECIFIC TOOLS

WOLFF

www.wolff.fr

	ROMUS	JANSER	WOLFF
TRACER FOR COVING - 200 mm substrate bead	Ref. 95430	Ref. 222 430 100	
ADHESIVE SPATULA WITH INTERCHANGEABLE BLADE (18 CM)			
A 2 BLADE TKB STANDARD			
A 4 BLADE TKB STANDARD			
PRESSURE ROLLER - steel \varnothing 30 x 45 mm		Ref. 224 400 125	Ref. 111 200 000
COVING RULER - For cutting flooring 13 cm and 10 cm from the floor, for coving		Ref. 224 432 000	
CORK BLOCK FOR BONDING	Ref. 93145	Ref. 262 380 000	Ref. 720 930 000
COMBINED TRACER AND MARKING GAUGE - (spur 1 mm thick)	Ref. 09335	Ref. 262 130 500	
SPARE BLADE (in 5s)	Ref. 93356	Ref. 262 415 001	
SPARE POINT \varnothing 1,5 mm (in 20s)	Ref. 93357	Ref. 262 126 000	
ROLLER FOR INTERNAL ANGLE	Ref. 093135	Ref. 224 400 123	Ref. 116 340 000
ROLLER FOR EXTERNAL ANGLE		Ref. 262 614 000	Ref. 116 350 000
COVING FINISHING TOOL			
HOT CHAMFERING GOUGE FOR TARASFE			
ULTRA FAST NOZZLE		Ref. 224 800 007	
SPEED NOZZLE WITH BLOW HOLES	Ref. 95030	Ref. 224 700 300	
TRIANGULAR SCRAPER with interchangeable blade	Ref. 95185	Ref. 262 607 000	Ref. 721 030 000
SPARE BLADE		Ref. 262 627 001	Ref. 721 031 000
FINISHING SPATULA - For finishing flooring with projections		Ref. 262 609 100	Ref. 116 400 000 Ref. 116 402 000
PRESSURE BALL - Brass - \varnothing 13 mm - For rounding joints in angles		Ref. 224 816 000	Ref. 116 200 000
ROUNDED BALDE \varnothing 4 mm - For sharpening finishing spatulas and cleaning nozzles	Ref. 95191	Ref. 262 609 102	

ACCESSORIES AVAILABLE FROM GERFLOR

DRAINS : INOX / SITAR / SITAR V

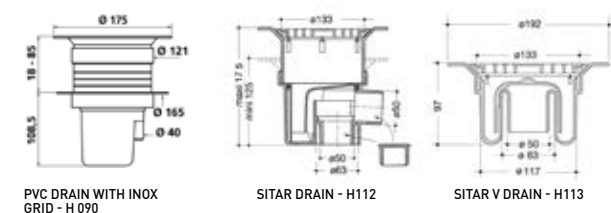

ANGLE BEAD CA 12 (H204)

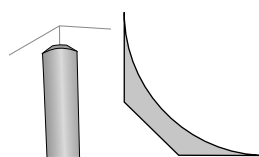

COVE FORMER (0478)

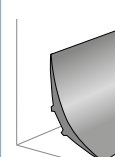

DIMINISHING PROFILE (0490)

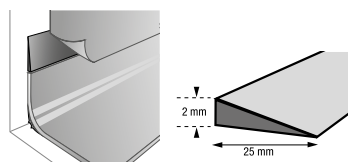

SHOWER THRESHOLD PROFILE (0469)

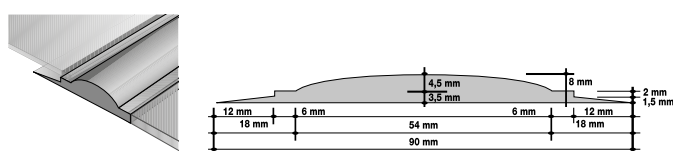

OTHER RECOMMENDED ACCESSORIES, NOT AVAILABLE FROM GERFLOR

MASTIC - BOSTIK SA - Ref. : POLYMER MS107 de BOSTIK

TARADOUCHE SHOWER SYSTEM FLOORINGS

	Cleaning methods	
First use	<ul style="list-style-type: none"> • Damp sweeping • Manual cleaning with a scrubbing brush • Recovery of solid water with a flat mop <ul style="list-style-type: none"> • Rinsing with clean water 	
	<ul style="list-style-type: none"> • Damp sweeping • Mechanical washing at 300-450 rpm (with water recovery) 	
Daily cleaning	<ul style="list-style-type: none"> • Damp sweeping • Manual washing with flat mop <ul style="list-style-type: none"> • Rinsing or • Steam cleaning 	
Deep cleaning	MANUAL CLEANING	MECHANICAL CLEANING
	<ul style="list-style-type: none"> • Damp sweeping • Manual cleaning with a scrubbing brush • Recovery of solid water with a flat mop • Rinsing with clean water 	<ul style="list-style-type: none"> • Damp sweeping • Mechanical washing at 300-450 rpm (with water recovery)

WALL COVERINGS

		Cleaning methods
First use		<ul style="list-style-type: none"> • Manual cleaning with an alkaline detergent + sponge without abrasive <ul style="list-style-type: none"> • Recovery of water with a microfibre disposable mop • Rinsing with clear water
Daily cleaning	Once a day	<ul style="list-style-type: none"> • Manual cleaning with a sponge without abrasive + neutral detergent for the surfaces located in areas 1 or 2 and a disinfectant detergent for the surfaces located in areas 3 and 4 and eventually in area 2 <ul style="list-style-type: none"> or • Steam cleaning
Periodical cleaning	Once a month and at patient's departure in areas 1 and 2 Once a week and at patient's departure in areas 3 and 4	<ul style="list-style-type: none"> • Manual cleaning with a disinfectant detergent (without amine) and a sponge without abrasive <ul style="list-style-type: none"> or • Steam cleaning (if manual daily maintenance)
Deep cleaning	Once a month	<ul style="list-style-type: none"> • Manual cleaning with an alkaline detergent + a sponge without abrasive <ul style="list-style-type: none"> • Rinsing with clear water



PRECAUTIONS FOR USE:

- Never use abrasive disks or any procedure that risks damaging the surface treatment (abrasive products, solvents, etc.).
- Never use rubber caps (for chair legs or other furniture); instead, use PVC or Polyethylene caps.

MURAL CALYPSO

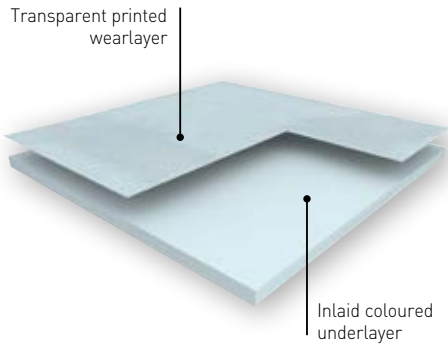

ELEGANCE SD

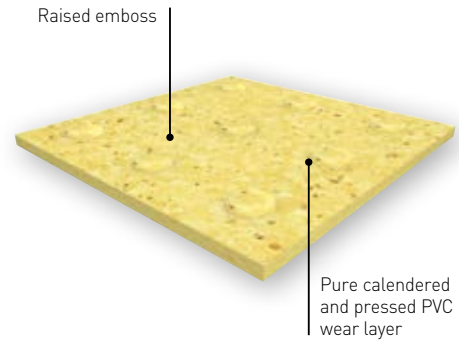

MURAL CALYPSO

MURAL CALYPSO is a multilayered wall covering in 2m width roll and with a **B-s2,d0 fire classification** according to EN 13501.

It is hot welded with CR41 welding rods for a perfect water tightness.

It is made of a printed transparent wear layer and a **coloured** under layer for a better aspect of the welding. This layer comprises 20% of recycled products.

It does not contain any CMR 1 & 2 component and is 100% compliant with REACH.

It is 100% recyclable.

This wall covering is specially recommended for wet room areas and makes the installation in angles easier thanks to its flexibility.

The Shower System is compliant with most laws on "access for all" thanks to the installation in shower without tray.

ELEGANCE SD

ELEGANCE SD is a flexible homogeneous calendared compacted floorcovering available in 2 m sheet, with a non-directional polychrome design, to offer an even colour throughout the thickness. It should be hot welded with a CR 40 welding rod for a perfect watertightness.

ELEGANCE SD is specifically embossed for wet barefoot traffic and has a group P wear rating.

ELEGANCE SD is compliant with antislip resistance norms (R9 according to DIN 51130 and B classification according to DIN 51097) for a **safe usage** in barefoot or shod applications such as showers. The Taradouche System enables access for all in showers especially for disabled people.

It is made of 32% mineral material and 34% renewable material. It uses 100% controlled recycled material. The TVOC emissions in the air at 28 days (EN 16000) are < 10 µg / m³. It is 100% recyclable.

TARASAFE

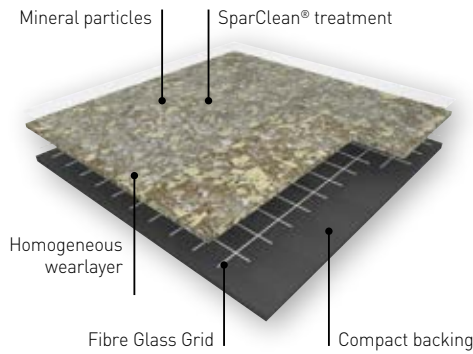

TARASAFE ULTRA H2O

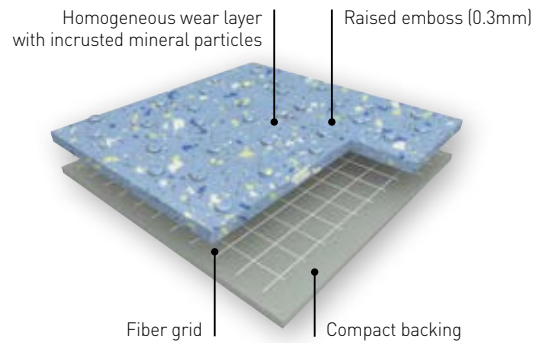

TARASAFE

TARASAFE STANDARD, ULTRA and GEO is a slip resistant vinyl floorcovering, with a PVC wear layer and deeply inlaid mineral particles and coloured chips for a decorative design and better slip resistance.

TARASAFE STANDARD, ULTRA and GEO is an ideal solution for traffic applications where enhanced slip resistance and durability are required. The mineral particles gives a Class B barefoot slip resistance (DIN 51 097) and R10 shod slip resistance (DIN 51 130).

It is reinforced with a glass fibre grid in sheet form. Its homogeneous wear layer provides a group T of abrasion.

It has a surface treatment which avoids acrylic emulsion during the whole life of the product and makes maintenance easier.

It does not contain any heavy metals or CMR 1&2 and it is 100% compliant with REACH. The product emission rate of volatile organic compounds is <math>< 100 \mu\text{g}/\text{m}^3</math> (TVOC after 28 days – ISO 16000 -6). This product is 100%.

TARASAFE ULTRA H2O

TARASAFE ULTRA H2O is a slip resistant vinyl floorcovering, with a PVC wear layer and deeply inlaid mineral particles and coloured chips for a decorative design together with a raised emboss for better slip resistance.

TARASAFE ULTRA H2O is an ideal solution for traffic applications where enhanced slip resistance with barefoot and durability are required such as wet areas. The specific embossing together with the mineral particles gives a Class C barefoot slip resistance (DIN 51 097) and R11 shod slip resistance (DIN 51 130) which makes **TARASAFE ULTRA H2O** ideal for barefoot or shod applications.

It is reinforced with a glass fibre grid in sheet form. Its homogeneous wear layer provides a group P of abrasion.

It does not contain any heavy metals or CMR 1&2 and it is 100% compliant with REACH. The product emission rate of volatile organic compounds is <math>< 100 \mu\text{g}/\text{m}^3</math> (TVOC after 28 days – ISO 16000 -6). This product is 100% recyclable and contents 18% of mineral material and 22% of inexhaustible material.



TECHNICAL DATASHEET

	MURAL CALYPSO	ELEGANCE SD	TARASAFE			TARASAFE ULTRA H ₂ O
			Geo	Ultra	Standard	Ultra

DESCRIPTION

Total thickness	EN ISO 24346 [EN 428]	mm	0.92	2.4 (on grainside)	2	2 (on grainside)
Thickness of wearlayer	EN ISO 24340 [EN 429]	mm	0.10	2.4	0.80 - 1.00	1.00
Weight	EN ISO 23997 [EN 430]	g/m ²	1610	3100	2360	2400
Width of sheet	EN ISO 24341 [EN 426]	cm	200	200	200	200
Length of sheet	EN ISO 24341 [EN 426]	m	30	20	20	20

CLASSIFICATION

Product specification	-	-	EN 15102	EN ISO 10581 [EN 649]	EN ISO 10582 [EN 649]	EN ISO 10582 [EN 649]
European classification	EN ISO 10874 [EN 685]	class	-	34 - 43	34 - 43	34 - 43
Fire rating	EN 13 501-1	class	Bs2,d0	Bfl-s1	Bfl-s1	Cfl-s1
Static electrical propensity	EN 1815	kV	-	< 2	< 2	< 2
Slip resistance wet	DIN 51 097 (barefoot) DIN 51 130 (ramp test with oil)	class	-	B R9	B R10	C R11
Determination of slip resistance – barefoot & shod + water	EN 13845-annexe C	class	-	-	ESf - ESb	ESf - ESb
Water tightness	EN 13553	-	-	OK	In progress	In progress



PERFORMANCES

Wear resistance	EN 660.2	mm ³	-	≤ 4.0	≤ 2.0	≤ 4.0
Wear group	[EN 649]	group	-	P	T	P
Type Binder content	ISO 10582 ISO 10581	type	-	I I	I -	I -
Dimensional stability	EN ISO 23999 [EN 434]	%	-	≤ 0.40	≤ 0.40	≤ 0.40
Impact sound Insulation	EN ISO 717-2	dB	-	-	6	-
TARAFOAM Impact sound Insulation	EN ISO 717-2	dB	-	In progress	In progress	In progress
Residual indentation (requirement)	EN ISO 24343-1 [EN 433]	mm	-	≤ 0.10	≤ 0.10	≤ 0.10
Residual indentation (measure)	EN ISO 24343-1 [EN 433]	mm	-	~ 0.03	~ 0.03	-
Thermal conductivity	EN ISO 10456 [EN 12 524]	W/(m.K)	-	0.25	0.25	0.25
Colour fastness	EN 20 105 - B02	degree	≥ 6	≥ 6	≥ 6	≥ 6
Chemical resistance	EN ISO 26987 [EN 423]	class	OK	OK	OK	OK
Surface treatment	-	-	-	-	SparClean® PUR	-
Anti-bacterial activity [E. coli – S. aureus – MRSA] ⁽¹⁾	ISO 22196	-	> 99% inhibits growth	-	> 99% inhibits growth	> 99% inhibits growth

ENVIRONMENT / INDOOR AIR QUALITY

TVOC after 28 days	ISO 16001	µg / m ³	-	<10	<100	<100
Certification	-	-	-	Floorscore®	Floorscore®	Floorscore®

CE MARKING

CE	EN 15102	-	OK	-	-	-
	EN 14041	-	-			

(1) The implementation of an effective cleaning method is the best defence against infection.

GERFLOR SERVICES

PARTNER FOR ALL YOUR PROJECTS!

TECHNOCENTRES AROUND THE WORLD



A TECHNICAL ASSISTANCE

A technical team moves on your construction sites in order to support you in situ.

A KNOWN EXPERTISE

Take the advantage of our expertise and build together a global solution for your project.

A LARGE PALETTE OF ACCESSORIES



Handrails



Wall Coverings & Protections



Entrance mats



Skirtings & Profiles

ONLINE SERVICES

Access to all our services on our website



WELDING RODS MATCHING

<http://weldingrods.gerflor.com>



VIRTUAL LIBRARY

Access to our documentation on line
<http://virtuallibrary.gerflor.com>

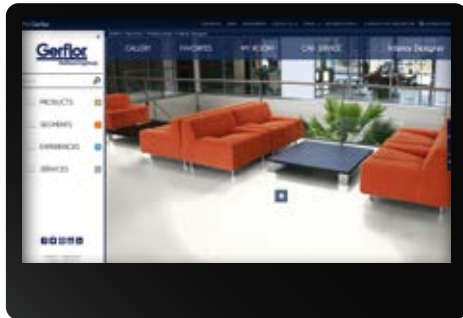

ROOM VISUALIZER "INTERIOR DESIGNER"





New Interior designer

Choose a picture or upload the picture of your own project, select a Gerflor floor and visualize in few clicks the results!

<http://interiordesignerpro.gerflor.com>

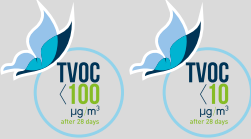
COMMITTED TO SUSTAINABLE DEVELOPMENT

ECO-RESPONSIBLE SOLUTIONS

 Health & safety	Selected and responsible raw materials	<p>NO heavy metal, NO solvent. NO formaldehyde, NO substance potentially subject to REACH* restrictions.</p>
	Low VOC emissions	<ul style="list-style-type: none"> - Comply with AgBB protocol - Floorscore certified - Volatile Organic Compound (VOC) emissions of <10 µg/m³ after 28 days for homogeneous products and <100 µg/m³ for heterogeneous products, using European procedures - No formaldehyde and carcinogenic emissions 
 Recycling	100% recyclable materials	<p>Gerflor will help recycle its products at the end of their life cycle</p>
	Recycled content	<ul style="list-style-type: none"> - On average, Gerflor floors are made of 25% recycled content - 100% of recycled materials are inspected and exempt from REACH* restrictions.
 ISO 14001	ISO 14001 certified	<ul style="list-style-type: none"> - Gerflor industrial sites hold ISO 14001 accreditation. - EPD available on www.gerflor.com
 Life-cycle analysis	Long life at low cost	<p>Opting for high quality «no polish for life» flooring such as one of our patented Protecsol®, Sparclean®, Evercare™ treated products, you can drastically reduce the usage of chemical product and water and ensure the best financial outcome but also the security of knowing the designs and colours will stand the test of time even in high traffic areas.</p>

*REACH is the new European regulation on registering, assessing and authorising chemical products within the European Union.

Please do not hesitate to ask us for a full assessment of your project.

CONTRIBUTION TO GREEN BUILDING CERTIFICATION

BREEAM (Building Research Establishment Environmental Assessment Method) is the oldest British Standard and one of the most used worldwide.

It's a standard reference in term of sustainable construction (with LEED and HQE).

It can easily be adapted to local regulation our floorings contribute to that building certification due to:

- LCA (Life Cycle Analysis), including the choice of safe raw materials
- VOC emissions: low formaldehyde level, our floorings comply with the Appendix ZA4 of the European Standard EN 14041:2004

Gerflor contribution

- Low emitting materials: Floorscore certified products
- Products containing pre-consumer recycled materials
- 2 LEED™ specialists part of Gerflor staff



LEED (Leadership in Energy and Environmental Design) issued by the USGBC (US Green Building Council), confirms that a building or a community has been designed and constructed using strategies to improve performance by saving energy, treating water, reducing CO₂ emissions, and improving indoor air quality our floorings contribute to that building certification (4 levels from certificate: silver, gold, platinum) due to:

- VOC emission (Floorscore compliant)
- recycled content

References:



KAUST University - Kingdom of Saudi Arabia
Photo credits: Oger international / KAUST University

OAK PARK COMMUNITY CENTER - Sacramento (California) - USA
Photo Credits: Dahlin Group Architecture Planning and Misha Bruk

ASIA: Gerflor Asia

Tel: +86 21 6357 8818 - Fax: +86 21 6357 8998
e-mail: gerflorasia@gerflor.com

AUSTRALIA/NEW ZEALAND: Gerflor Australasia Pty. Ltd

Australia Tel: 1 800 060 785 - New Zealand Tel: 0 800 630 119
e-mail: gerflor@gerflor.com.au

AUSTRIA/SWITZERLAND: Gerflor GmbH

Tel: +43 (0)72 29/70 800-0 - Fax: +43 (0)72 29/70 800-218
e-mail: austria@gerflor.com - switzerland@gerflor.com

BELGIUM/LUXEMBURG: Gerflor Benelux

Tel: +32 (0)3 766 42 82 - Fax: +32 (0)3 766 29 14
e-mail: gerflorbel@gerflor.com

CANADA: Gerflor International

Tel: +1 438 333 0752 - Fax: +1 438 380 5425
e-mail: gerflorcanada@gerflor.com

CHINA: Gerflor floorings (China) Co. Ltd.

Tel: +86 21 6357 8818 - Fax: +86 21 6357 8998
e-mail: gerflorchina@gerflor.com

FINLAND: Gerflor Oy

Tel: +358 (0) 10 6 17 5150 - Fax: +358 (0) 10 617 5152
e-mail: info@gerflor.fi

FRANCE: Gerflor - Service Express:

N°Azur 0 810 569 569 **N°Azur/FAX 0 810 569 570**

e-mail: contactfrance@gerflor.com

GERMANY: Gerflor Mipolam GmbH

Tel: +49 (0)22 41-25 30-0

e-mail: gerflormipolam@gerflor.com

Kunden-Service

Tel: +49 (0) 22 41-25 30-136 - Fax: +49 (0) 22 41-25 30-100

e-mail: kundenservice@gerflor.com

SAT Service und Anwendungstechnik

tel: +49 (0)22 41-25 30 555 - Fax: +49 (0)22 41-25 30 550

e-mail: technik@gerflor.com

IRELAND: Gerflor Ltd

Tel: +353 (0) 42 966 1431 - Fax: +353 (0) 42 966 1759

e-mail: gerflorirl@gerflor.com

ITALY: Gerflor S.p.A.

Tel: +39 02 90 40 10 - Fax: +39 02 90 42 74 84

e-mail: gerfloritalia@gerflor.com

LATIN AMERICA (Brazil): Gerflor América Latina

Tel: +55 11 38 48 20 20

e-mail: gerflor@gerflor.com.br

MIDDLE EAST: Gerflor Middle East

Tel: +966 13 847 1779 - Fax: +966 13 847 1781

e-mail: info@gerflorme.com

NETHERLANDS: Gerflor Benelux

Tel: +31 (0)40 266 17 00 - Fax: +31 (0)40 257 46 89

e-mail: gerflornl@gerflor.com

OTHER COUNTRIES: Gerflor International

Tel: +33 (0)4 74 05 40 00 - Fax: +33 (0)4 74 05 03 13

e-mail: gerflorcontract@gerflor.com

POLAND: Gerflor Polska Sp z o.o

Tel: +48 61 823 34 01 - Fax: +48 61 823 34 33

e-mail: info@gerflor.pl

PORTUGAL: Gerflor Iberia, SA

Tel: +351 21 843 95 49 - Fax: +351 21 846 55 44

e-mail: gerflorportugal@gerflor.com

RUSSIA: Gerflor zao

Tel./Fax: +7 495 785 23 71

e-mail: gerflorussia@gerflor.ru

SCANDINAVIA: Gerflor Scandinavia a.s.

Tel: +47 64 95 60 70 - Fax: +47 64 95 60 80

e-mail: gerflorscand@gerflor.no

SPAIN: Gerflor Iberia, SA

Tel: +34 91 653 50 11 - Fax: +34 91 653 25 85

e-mail: gerfloriberia@gerflor.com

UNITED KINGDOM: Gerflor Ltd

Sample service: Contractuk@gerflor.com

Office Tel: +44 (0) 1926 622 600 - Fax: +44 (0) 1926 401 647

USA: Gerflor North America

Tel: 877 GERFLOR (437 3567) - Fax: 847 394 3753

e-mail: info@gerflorusa.com



Committed to sustainable development

Gerflor. Don't forget our complementary ranges!



Handrails



Wall Coverings
& Protections



Entrance mats



Skirtings & Profiles

and *Be* CONNECTED!



www.gerflor.com

Gerflor
theflooringgroup